

Lithium Iron Phosphate (LiFePO4) Battery Specification

SLAUMXLI42-24(25.6V42AH)

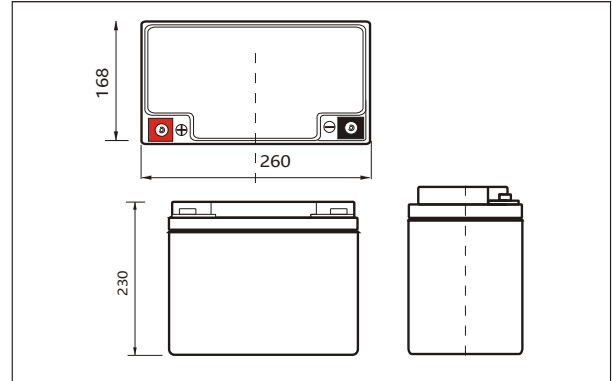

Outer dimensions (mm)



Specifications

Nominal Voltage	25.6V	
Rated capacity (20 hour rate)	42Ah	
Dimensions	Total Height	230 mm
	Height	230mm
	Length	260 mm
	Width	168 mm
Weight Approx	10 Kg	
Terminal	M8	

Terminal Type (mm)

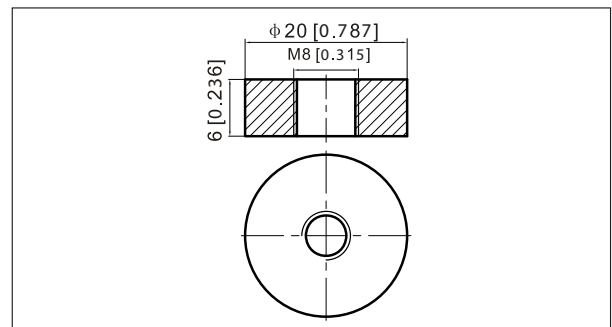

Characteristics

Capacity Retention	>80% at 28 days	
Cycle Life	>80% at 2000 Cycles	
1.5 hour discharge to 29.2V	3.00 A	
Internal Resistance	<20 mΩ	
Charge Characteristics	Charge Voltage	29.2±0.1V
	Charger Current	<20A
Discharge Characteristics	Max Continuous Current	50A
	Min Discharge Cut-off Voltage	20V
Temperature	Charge Temperature	0°C-45°C(32°F-113°F)
	Discharge Temperature	-20°C-60°C(-4°F-140°F)
	Storage Temperature	0°C-40°C(32°F-104°F)

Discharge Curves 25°C(77 °F)

